

FOUR-FOLD TOILET ROLL HOLDER WP163-S



353 x 350 x 120 mm
for 4 toilet paper rolls

- Four-fold toilet roll holder in robust, germ-reducing and easy-care stainless steel (AISI 304).
- All-stainless steel housing; visible surfaces satin finished and brushed. Further available surfaces: see below.
- Designed for four standard toilet rolls with dimensions:
Outer diameter max. 125 mm
Width max. 100 mm
Core diameter min. 38 mm
- Three concealed reserve rolls, each dropping down automatically.
- Inspection slot to indicate fill level.
- Accessible for refilling through lockable, hinged housing.
- Keyed alike cylinder lock in corrosion-resistant zinc die-casting.
- Wear parts can be replaced as modules.
- Mounting: With four screws through key holes and one optional anti-theft hole in the back wall.
- Delivery includes fixing material.
- Can be converted to WP163 at a later time:
Conversion kit ID 923 291.
- Weight, including single package: 6.1 kg



Suggested text for specifications:

Four-fold-toilet roll holder in stainless steel (AISI 304) for surface mounting. All-stainless steel housing; visible surfaces satin finished and brushed. Designed for four standard toilet rolls, three of them concealed reserve rolls, each dropping down automatically. Inspection slot to indicate fill level. Accessible for refilling through lockable, hinged housing. Keyed alike cylinder lock in corrosion-resistant zinc die-casting. Delivery includes fixing material.

Dimensions: 353 x 350 x 120 mm

Article No. WP163-S

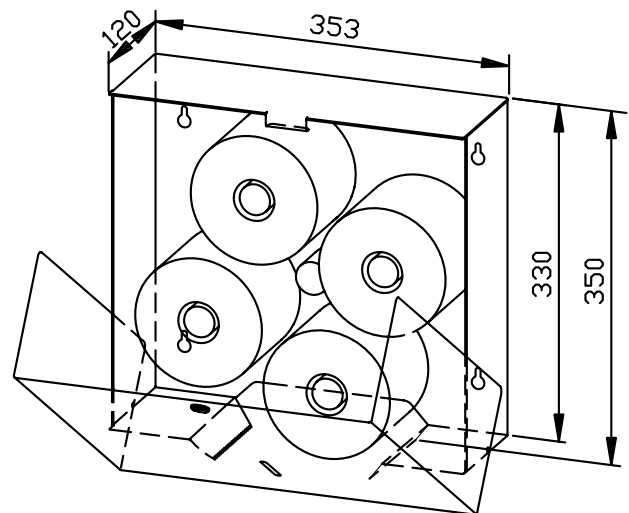

Available surfaces	ID No.
satin finished (standard)	727 290
highly polished	731 290
(coloured) plastic powder-coating	728 290

Ernst Wagner GmbH & Co. KG

Ernst-Abbe-Straße 21 · D-72770 Reutlingen · Tel.: +49712151539-0 · Fax: -20
info@wagner-ewar.de · www.wagner-ewar.de

WAGNER
EWAR